

Features:

- *Low battery alert* - alarm sounds when battery is low
- *Sounds* - two tone buzzer, high (90db), low (80db)
- Battery Test
- Auto-Reset
- Two Interfaces (connections) - Modular (telephone type) for flat sensors and mini-plug for alternative sensors
- Cable strain relief
- Shock resistance bumpers

Alarm Conditions

Condition

Alarm sounds when resident stands
Alarm sounds when modular connector or mini-phone plug are removed, while resident's sitting on sensor
Alarm sounds when sensor pad wire (grey) is cut, while resident is sitting on sensor. Alarm does not sound when auxiliary wire (black) is cut
Alarm sounds when batteries are low

Note: The alarm will not sound when the sensor pad wire (grey) is cut or accidentally pulled out unless it is activated. Also, when the sensor is activated by a resident sitting on it and the plug is accidentally pulled out it will ring but when re-inserted, the alarm will stop ringing. All of the conditions above apply either to the telephone type plug or mini-plug. The alarm sounds only when the mini-plug (black) is removed while sensor is activated. It will not ring when this wire is cut.

Reorder#	Description	Unit
909367	ChairPro Alarm Unit	Set
909366	ChairPro Alarm Unit	10/pk

OPERATION

1. Remove battery compartment cover on back of alarm unit and install two AA batteries, LED will light, steady.
2. Press "Battery Test" button. If alarm doesn't sound check battery connection and retest. If alarm fails to sound replace battery.
 - a. This alarm has a low battery alert and an alarm will sound during a "low battery condition".
3. Insert modular connector or mini-phone plug into the side of the alarm (Illustration A). Thread the wire through the "Cable Strain Relief" cavity as shown in (Illustration B) LED will flash. Make sure that there is some slack so that if the cord is tugged it doesn't put pressure on the connector. Alarm will sound. Press "Auto-Reset" button to silence alarm.
4. Before using, test unit by pressing the palm of your hand firmly against the sensor pad. While doing this, check alarm to make certain that LED is flashing. Remove your hand. Alarm should sound. Press "Auto-Reset" button to silence alarm. If alarm fails to sound, make certain the telephone type plug is secure.
5. Select High or Low alarm volume using the switch on right side of alarm, and select Tone 1 or 2
6. When alarm is activated by the resident leaving the wheelchair, it maybe silenced by pressing the "Auto-Reset" button. The alarm is now in stand-by mode. The system will automatically go into the monitoring mode when the resident is reseated. **There is no on/off switch.**

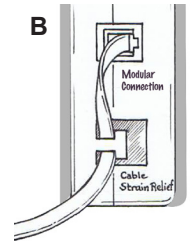
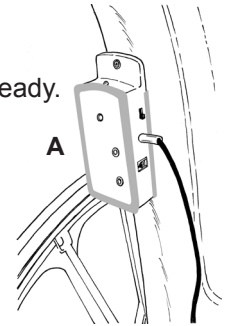

LED Conditions

Condition	Status
When battery is installed, no sensor	On Steady - Green Flash
Sensor pad plugged in	Green Slow Flash
Monitoring	Green/Red Flash
Alarm ring	Red Flash

Safety Reminders

1. Check battery before each use. If alarm is weak or fails to sound, replace the two AA batteries.
2. When unit is in use, check LED regularly. If it is not glowing, replace the two AA batteries.

INSTALLATION

You may choose one of the three methods to attach the alarm unit to the wheelchair

Mounting Bracket

1. Remove the second-from-top screw from either the left or right side of the wheelchair backrest (other locations may be chosen by the caregiver).
2. Remove grommet from screw, place the screw through hole on alarm unit mounting bracket, and fasten screw (with the grommet) to wheelchair backrest (Illustration C).

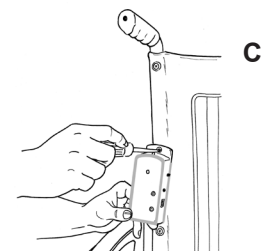

Continued on reverse side

INSTALLATION (contd.)

Cord Loop

1. Insert enclosed cord loop through bracket hole (Illustration D).
2. Hang from wheelchair push-handle (Illustration E).

Hook & Loop Tab

1. Remove the second-from top screw from either the left or right side of the wheelchair backrest.
2. Remove grommet from screw. Place screw through eyelet on hook & loop tab. Fasten screw to wheelchair backrest. Make certain that "Hook" side faces away from the wheelchair (Illustration F).
3. Remove backing from hook & loop strip with "Loop" material. Secure adhesive to back of alarm unit, above battery compartment cover (Illustration G).
4. Attach alarm unit to hook & loop tab (Illustration H).

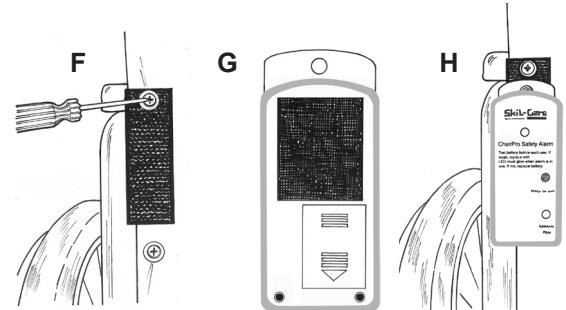
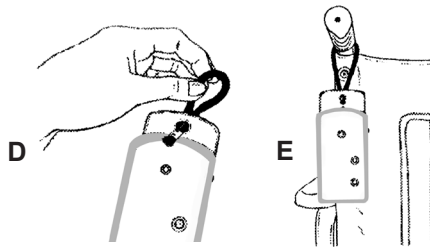

CAUTION

1. The ChairPro Sensor Pad Alarm is not a substitute for proper supervision. Fall-risk residents/patients should be monitored regularly.
2. Check battery each time alarm is used. If weak, replace the two AA batteries.
3. LED should flash when patient/resident is seated on the sensor pad. If LED fails to flash, check battery. Replace if necessary. If LED does not glow after battery is replaced, check sensor pad. Replace if necessary.
4. If patient/resident is seated on a wheelchair cushion, place sensor pad on top of cushion. This system may not work if sensor is placed beneath cushion.

BED INSTALLATION

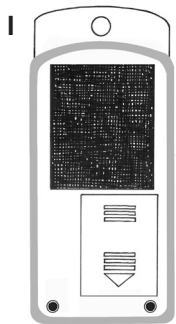

1. Remove backing from enclosed loop material hook & loop strip. Secure adhesive to back of alarm unit above battery compartment cover (Illustration I).
2. Remove backing from enclosed hook material hook & loop strip. Secure adhesive to the side of the headboard that faces the wall (Illustration J) Mount unit to headboard by pressing hook & loop material on unit against hook material on headboard (Illustration K).

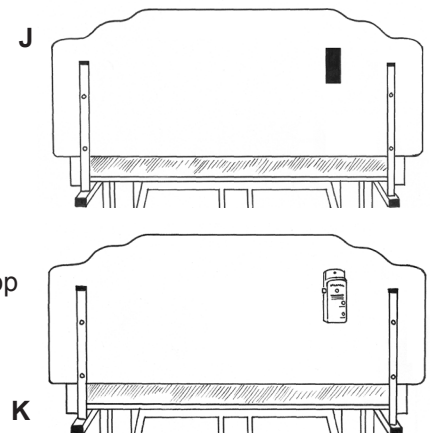

BED SENSOR PADS